

WINAM GROUP



DASH PARKOUR

ASENNUSOHJE
MONTERINGSANSVISNING
INSTALLATION INSTRUCTION
AUFBAUANLEITUNG
NOTICE D'INSTALLATION

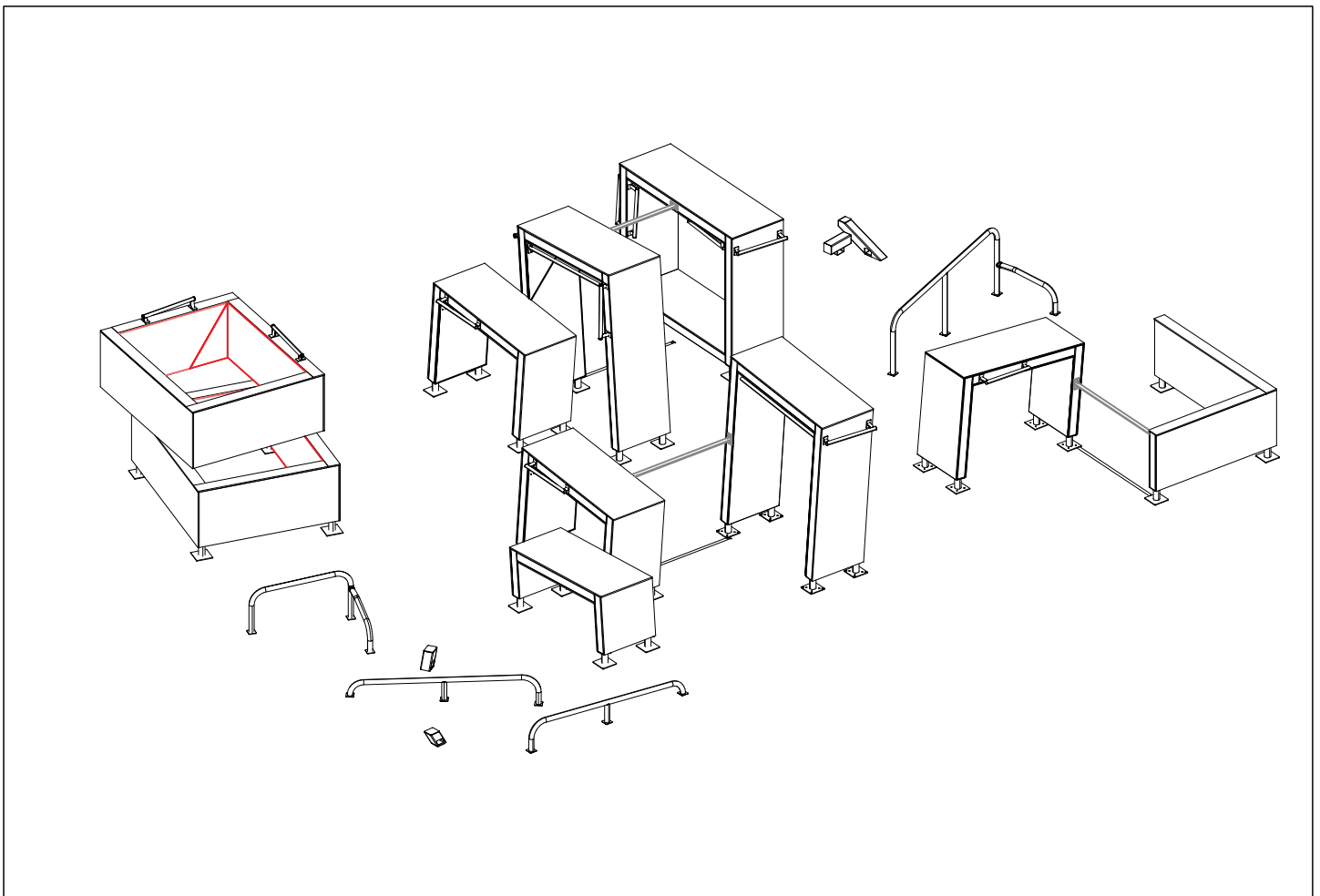

DATE: 18.2.2020

081784M

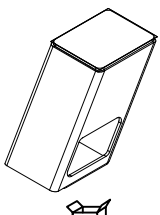
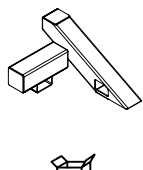
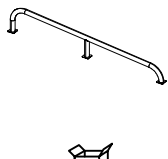
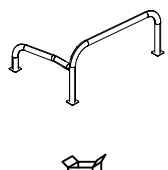
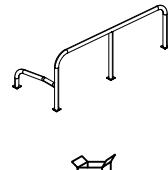
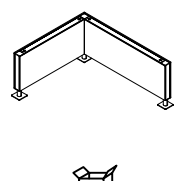
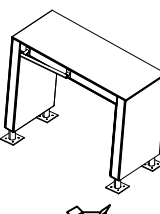
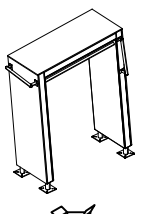
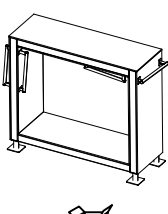
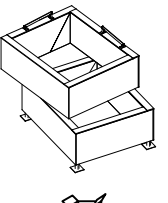
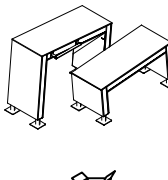
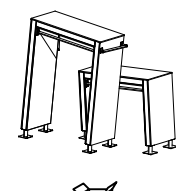
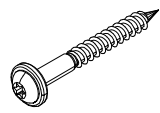

DASH PARKOUR

DATE: 18.2.2020

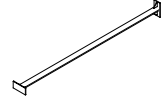
081700M  Ø8x70	PCS 2	081701M  L 1466	PCS 1	081710M  L 1466	PCS 2	081711M 	PCS 1	081712M 	PCS 1	081722M 	PCS 1
081731M 	PCS 1	081732M 	PCS 1	081733M 	PCS 1	081734M 	PCS 1	081735M 	PCS 1	081737M 	PCS 1
900240 	PCS 24	910328 	PCS 1	910513 	PCS 2		PCS		PCS		PCS
	PCS		PCS		PCS		PCS		PCS		PCS
	PCS		PCS		PCS		PCS		PCS		PCS
	PCS		PCS		PCS		PCS		PCS		PCS
	PCS		PCS		PCS		PCS		PCS		PCS

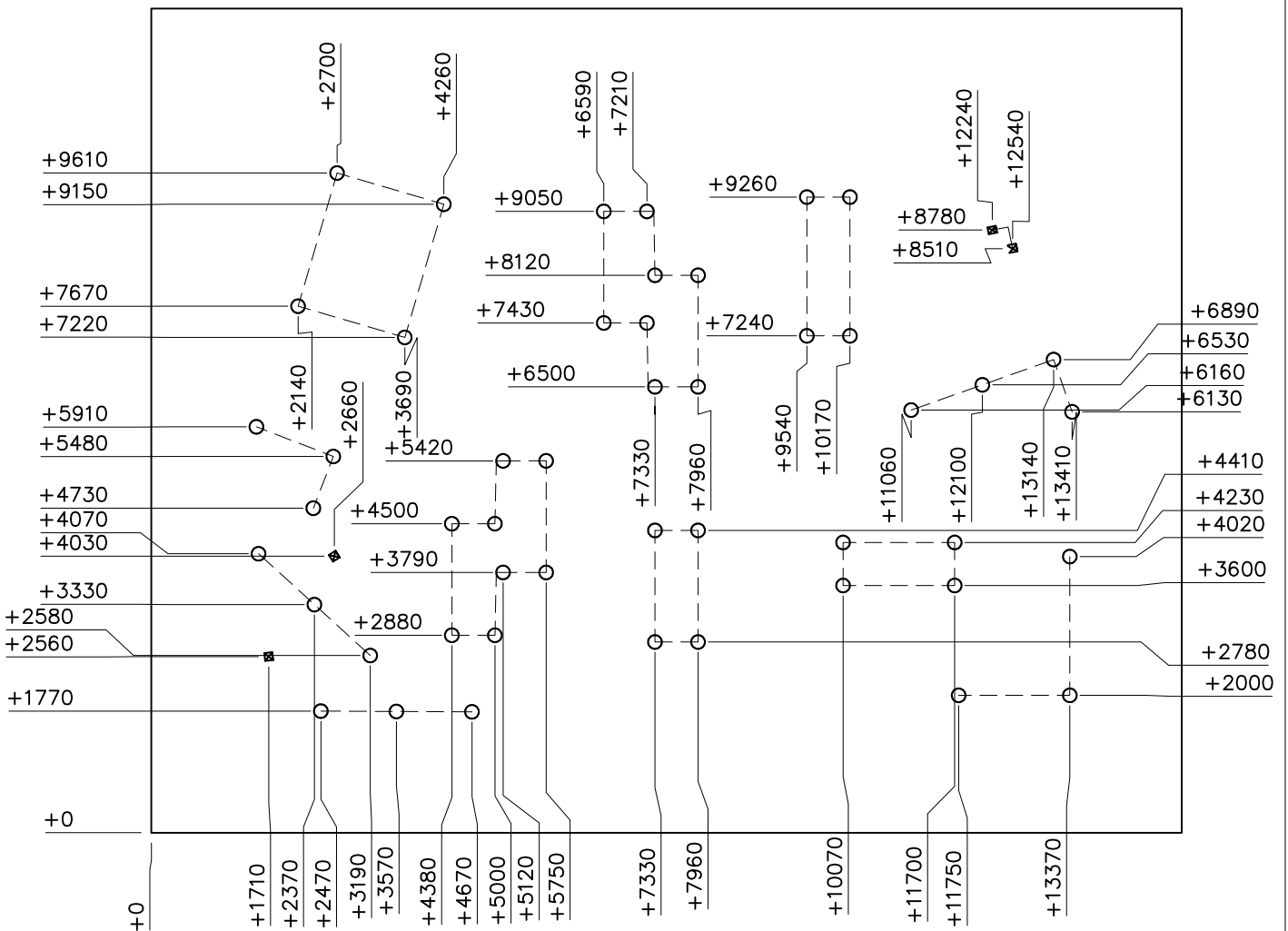
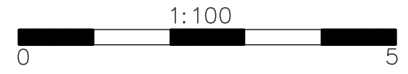

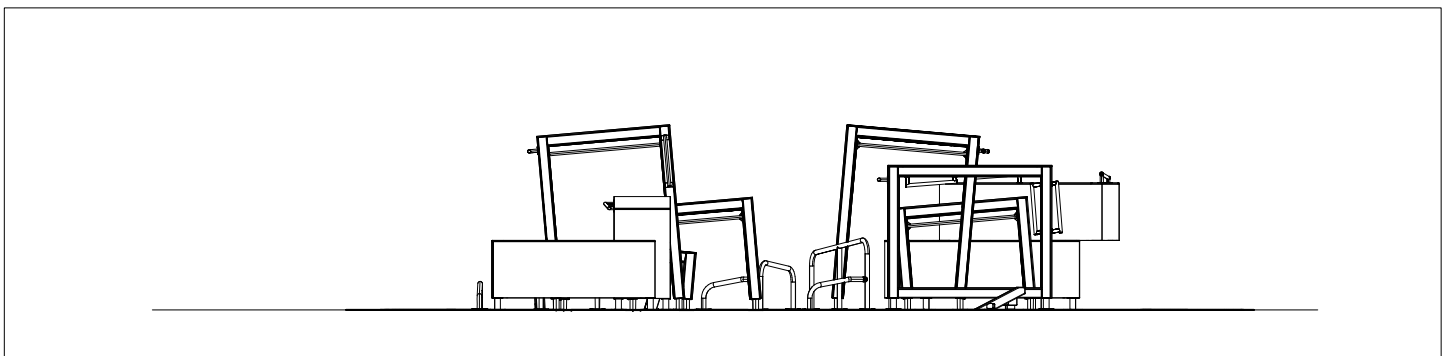
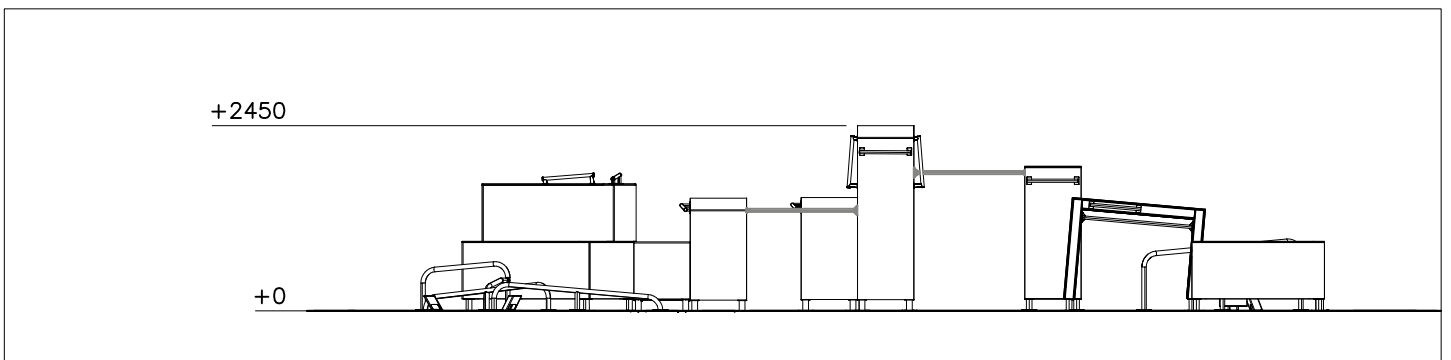
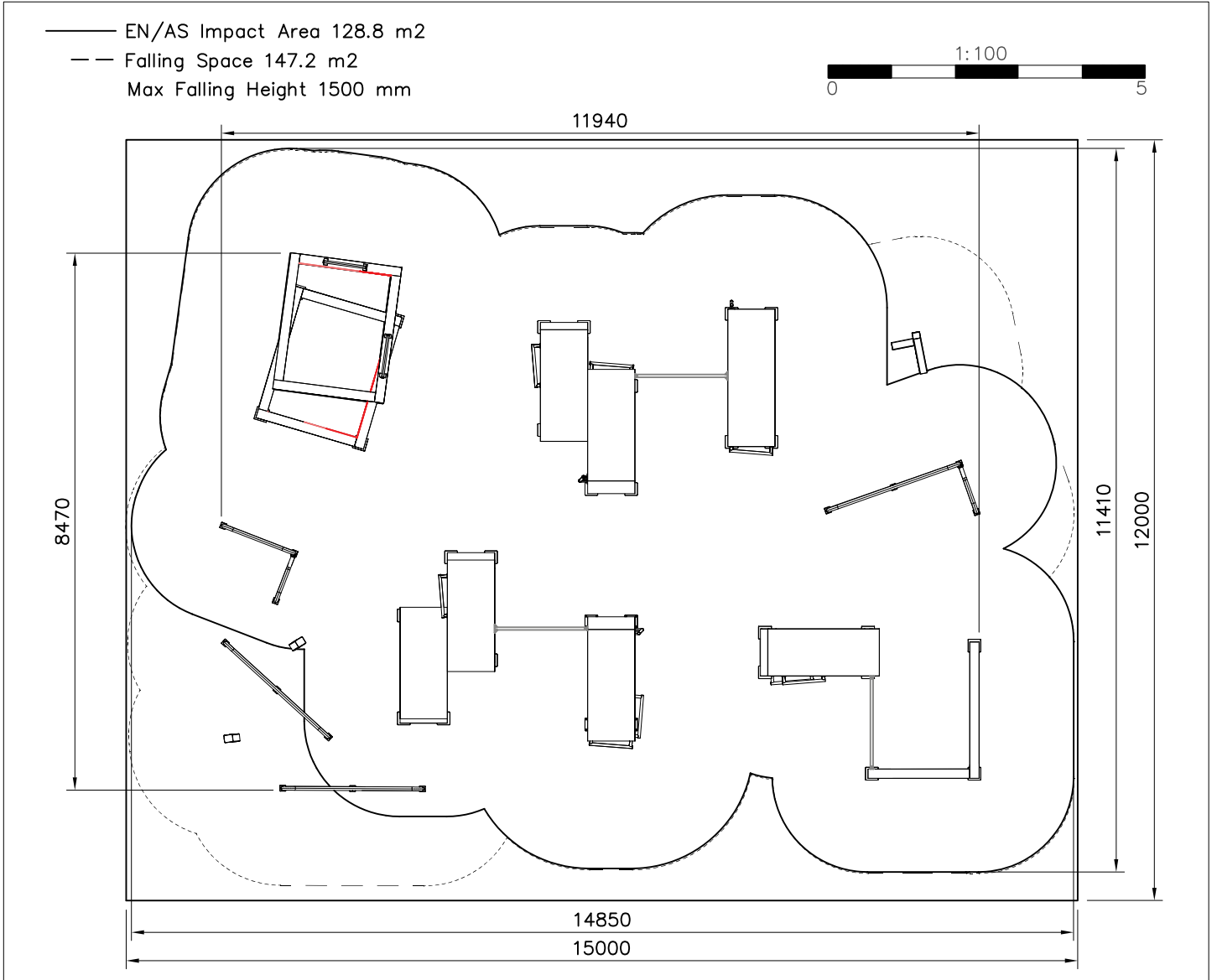

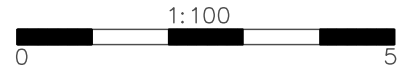

Groundmarks

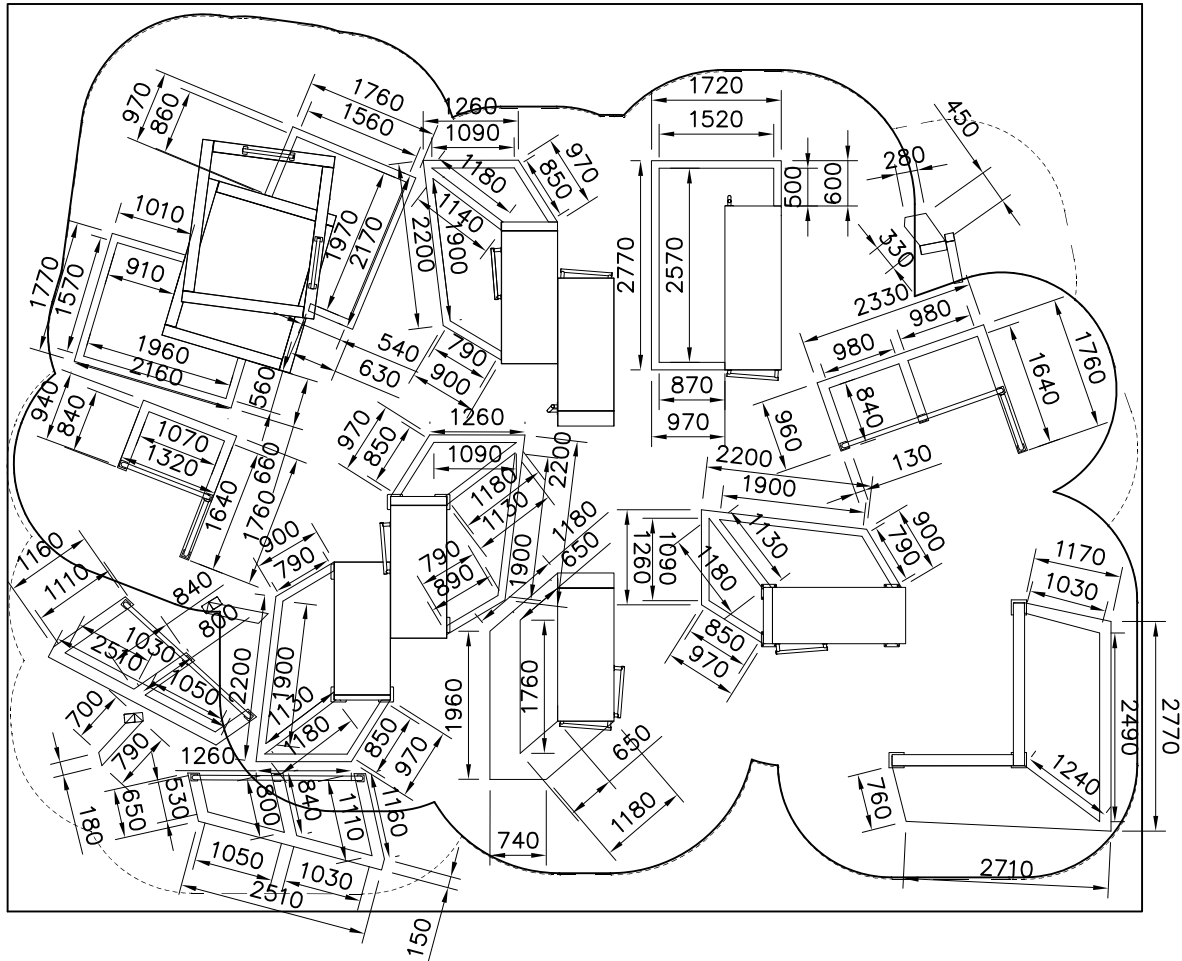

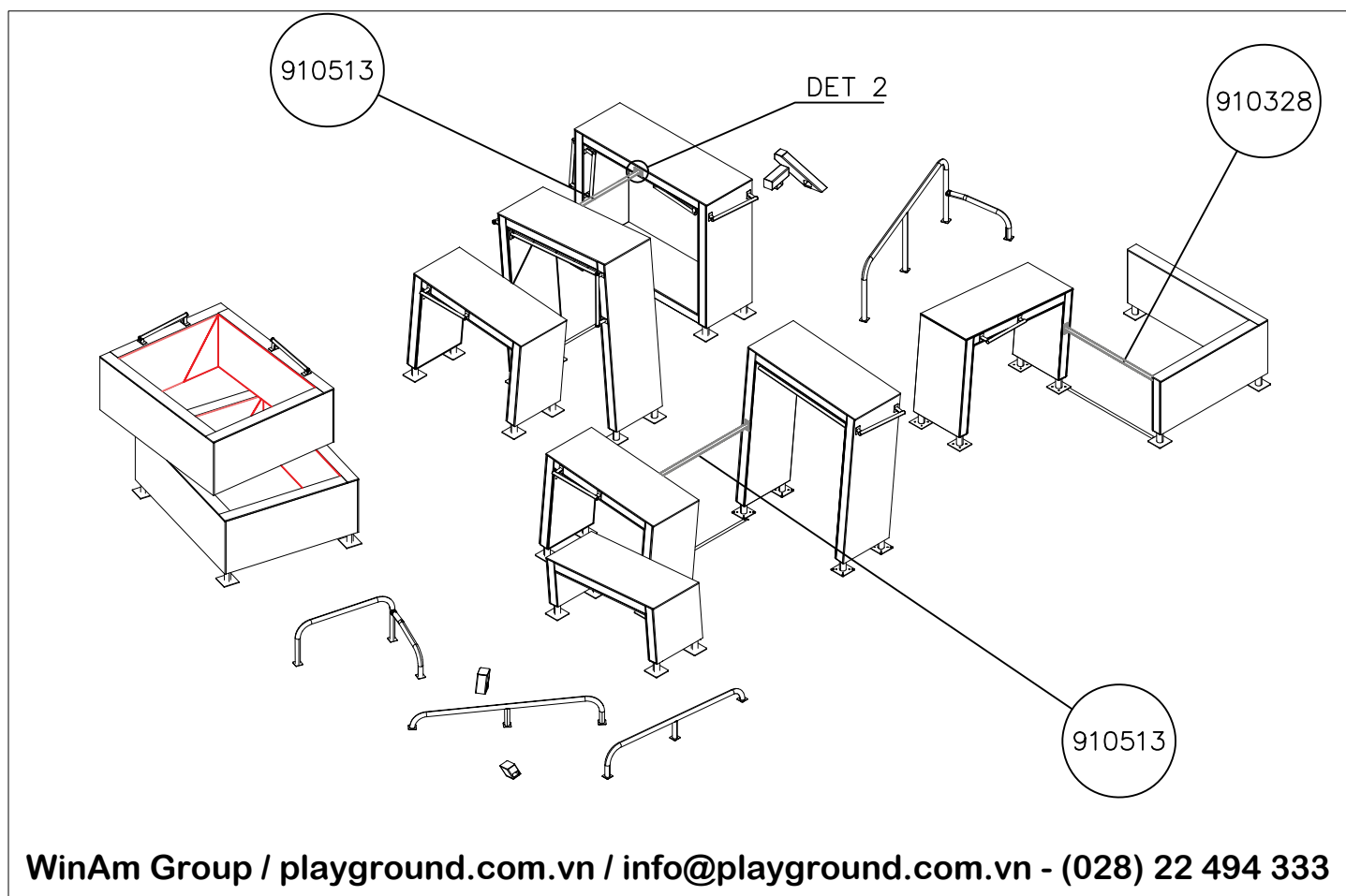
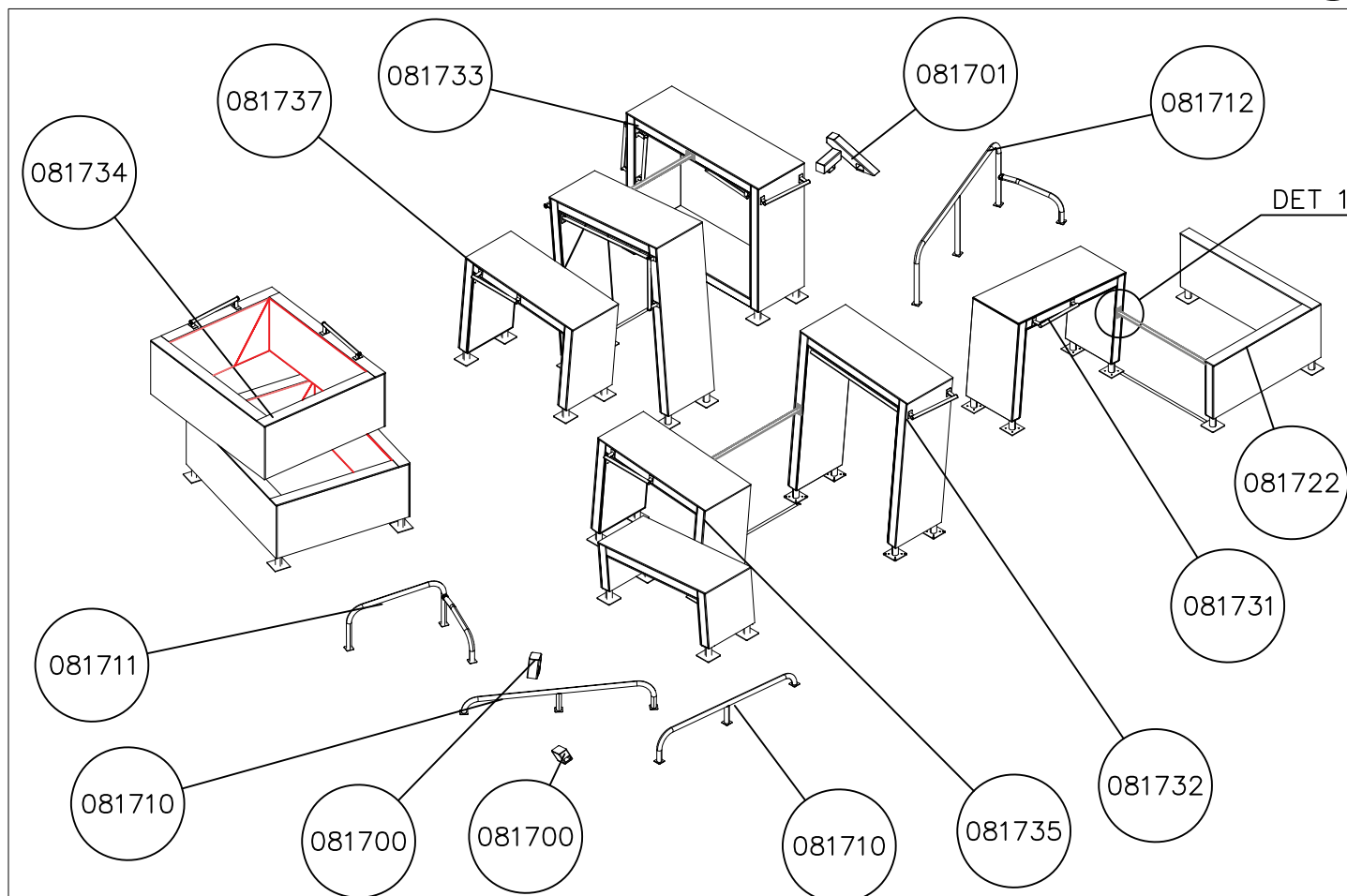

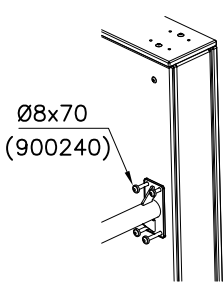
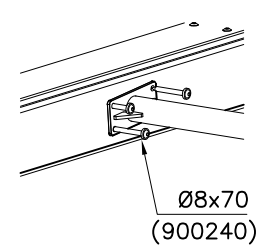
<p>DET 1</p>  <p>Ø8x70 (900240)</p>	<p>DET 2</p>  <p>Ø8x70 (900240)</p>		

