

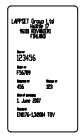









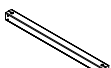
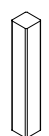
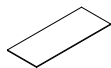

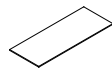

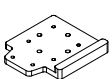
① 702341  90x50	PCS 1	② 707213  118x118x1490	PCS 4
③ 707517  118x118x1892	PCS 4	④ 708137  118x118x745	PCS 4
⑤ 708836  15x745x1736	PCS 2	⑥ 708837  15x745x2168	PCS 2
⑦ 708839  15x745x1897	PCS 1	⑧ 708840  15x148x2018	PCS 2
⑨ 708841  15x148x1616	PCS 2	⑩ 708857 JIG  20x133x149	PCS 1
⑪ 911288 COLOR  15x745x1465	PCS 2	⑫ 911289 COLOR  15x745x1897	PCS 1
⑬ 980123  Ø7x60	PCS 108	⑭ 900240  Ø8x70	PCS 64
⑮ 903093  Ø8x90	PCS 32	⑯ 905103  PT-28/32-H	PCS 16

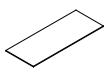

⑰ 905112	PCS	⑱ 910266	PCS		PCS		PCS		PCS		PCS
	32		16								
Ø22		90x108x118									

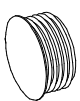
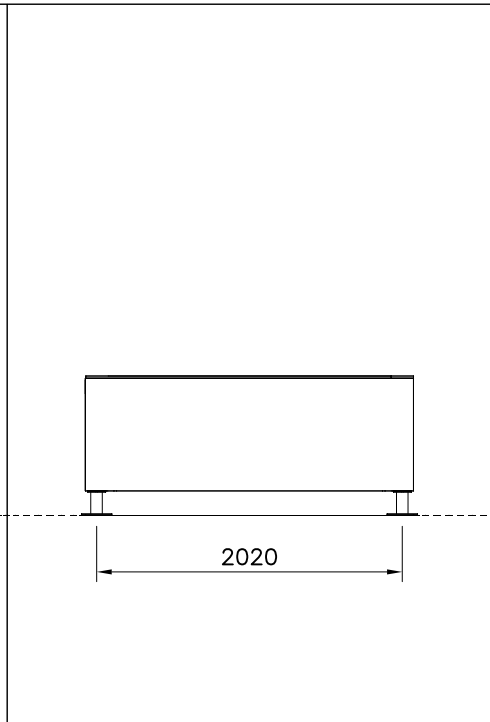
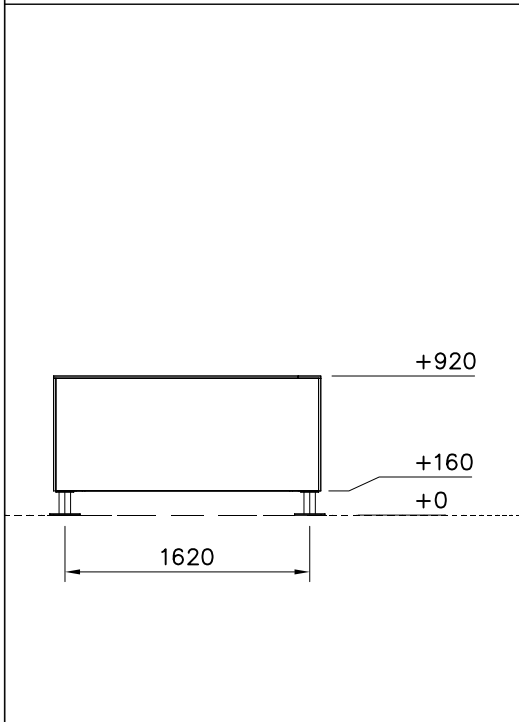
FOOT OPTIONS

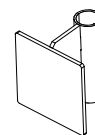
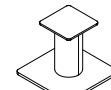
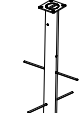
709261+		709262+	
○ 910330	PCS	○ 910567	PCS
SURFACE	4	CONCRETE	4
			
152x200x200		117x117x715	

----- Falling Space 22.7 m²
Max Falling Height 920 mm

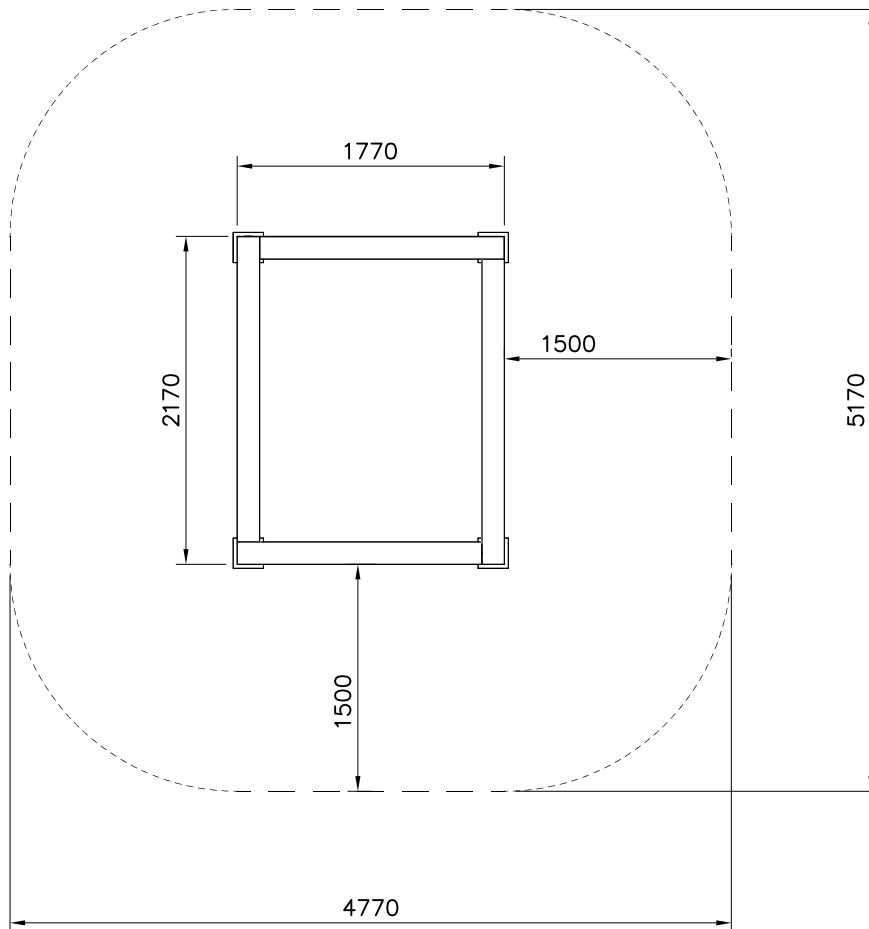
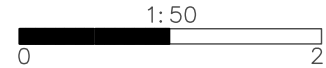

DET 1

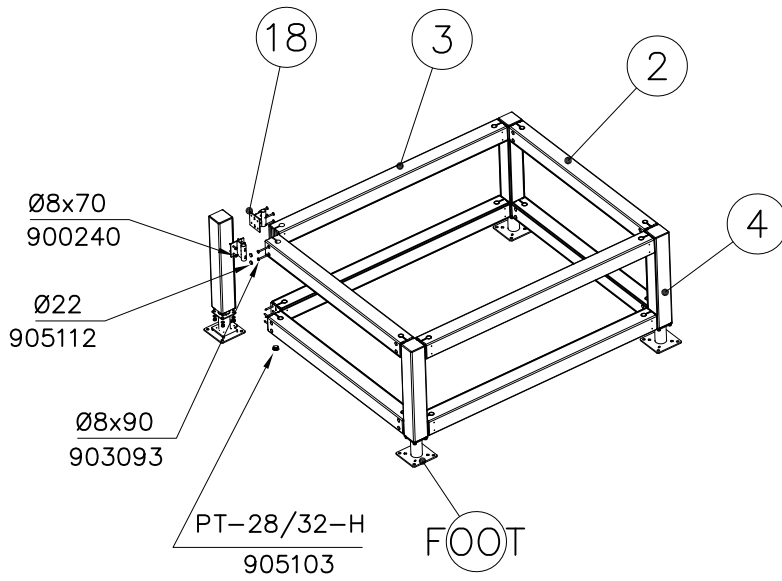

NOTE:
Use drill jig 708857
to predrill $\varnothing 5 \nabla 50$
holes for 910266

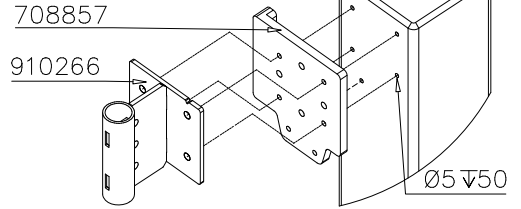

DET 2

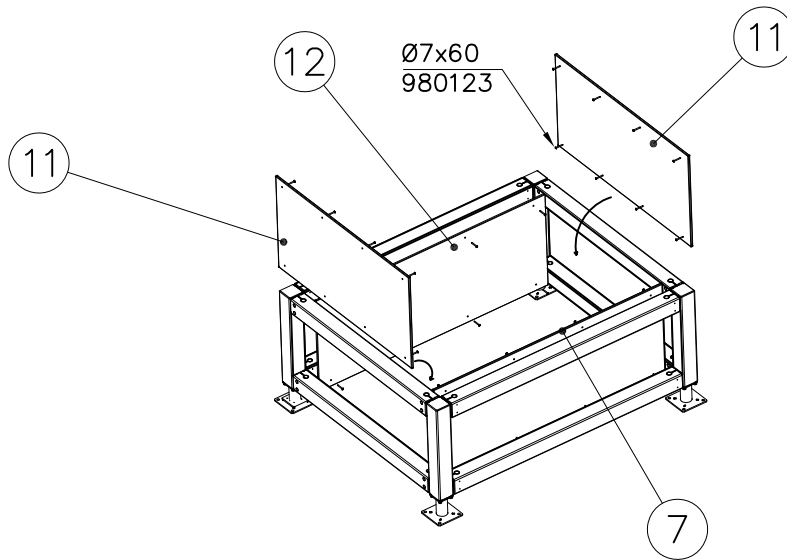

DET 3

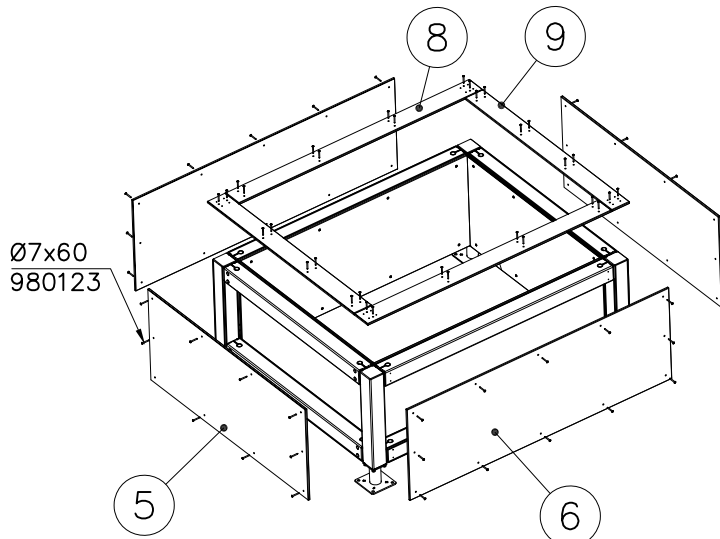

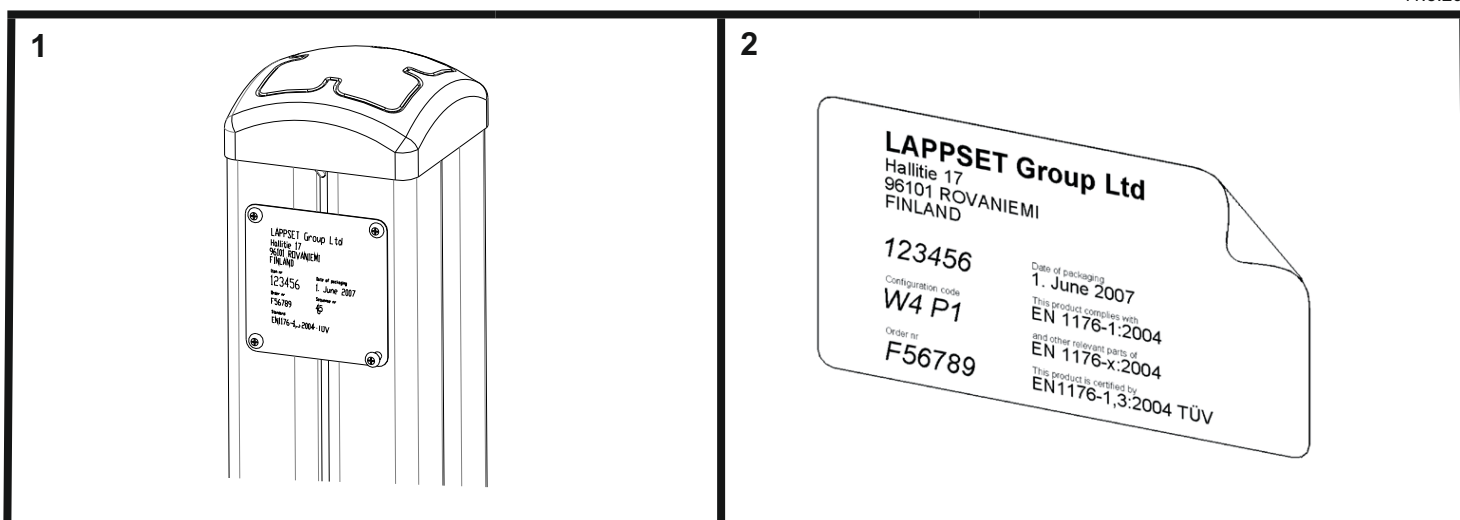

Tuotekyltti tulee tuotteen mukana yhdellä seuraavista tavoista:

1) Metallinen tuotekyltti ja kiinnitysruuvit

- Kiinnitä tuotekyltti ruuveilla tolppaan noin 2 metrin korkeuteen kuvan 2 mukaisesti.

2) Tuotekylttitarra

- Puhdista maalattu metalli- tai vaneripinta pölystä ja kosteudesta. Liimaa tarra kuvan 3 mukaisesti.
- Huom. Älä kiinnitä tarraa karheapintaiseen laminaattiin tai maalattuun puuhun.

Vår produktmärkning levereras på ett av följande sätt:

1) Produktskylt i metall

- Fäst skylten med de medföljande skruvarna

2) Självhäftande produktetikett

- Rengördenpulverlackerademetallytanellerlaminatytansåttndenblirfrifrånsmutsochfukt.Fästetikettenenligtfig.3.
- Obs! Fäst ej etiketten på detaljer med skrovlig yta eller på målat trä.

Product label is delivered by one of following ways:

1) Metal product label and screws

- Fasten the label with screws.

2) Label sticker

- Cleanthepaintedmetalorplywoodsurfacefromdirtandmoisture.Fastenthestickerasshowninthefigure3.
- Note. Do not attach the sticker to rough surfaced laminate or painted wood.

La plaque d'informations produit est livrée sous l'une de ces 3 formes :

1) Plaque métallique et vis

- Fixez la plaque à l'aide des vis.

2) Etiquette autocollante

- Avant de coller l'étiquette, nettoyez le composant métallique peint ou la plaque de contreplaqué, de toute saleté. La surface doit être sèche (voir image 3).
- Attention, ne pas coller l'étiquette sur une surface lamellé-collée irrégulière ou sur du bois peint.

Die Auslieferung des Produktaufklebers erfolgt auf eine dieser Arten:

1) Produkt-Schild aus Metall incl. Schrauben

- Die Befestigung des Schildes erfolgt mittels der Schrauben.

2) Aufkleber

- EntfernenSiezunächstSchmutzundFeuchtigkeitvomlackiertenMetallbzw.vonderHolzoberflächeundbringenSiedenAufkleber wie im Bild oben rechts beschrieben auf den gesäuberten Untergrund auf.
- Beachten Sie: Bringen Sie den Aufkleber nicht auf raues laminiertes oder lackiertes Holz an.

WINAM GROUP

SURF. FOUNDATION

709261

DATE: 15.8.2019

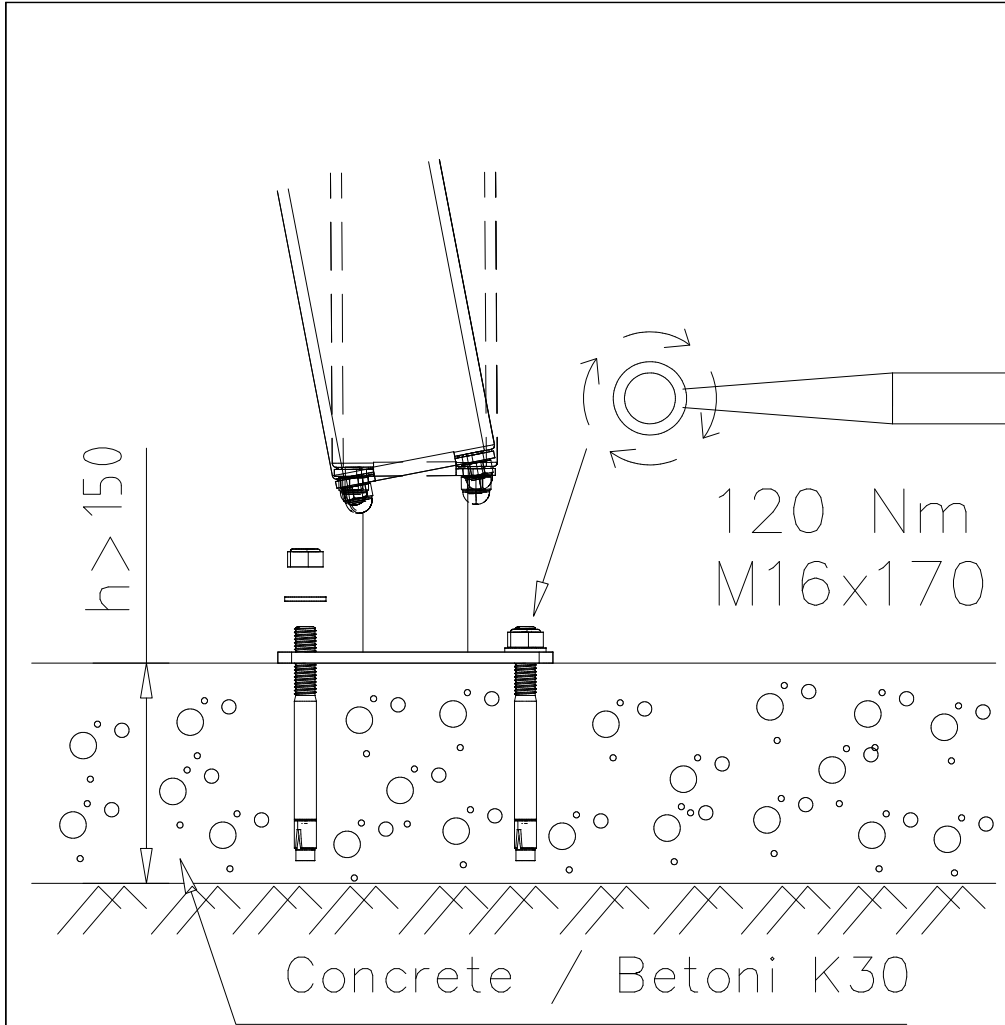

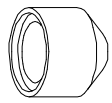
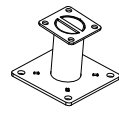
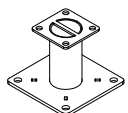
① 904450	PCS	② 905104	PCS
	4		4
M16x170		M10	
	PCS		PCS
	PCS		PCS
○ 910267	PCS	○ 910330	PCS
	1		2
152x200x200		152x200x200	
	PCS		PCS

$\varnothing 16 \downarrow > 130$

